



Lookout

008.001.008.001

blue rabbit



© 2018

Blue Rabbit 2.0 - Hemelrijken 8 - B-2890 St-Amands - Belgium.
Copyrighted material - Do not reproduce under penalty of law.

①

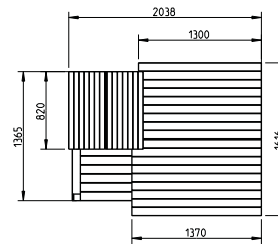
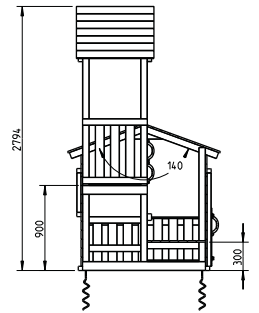
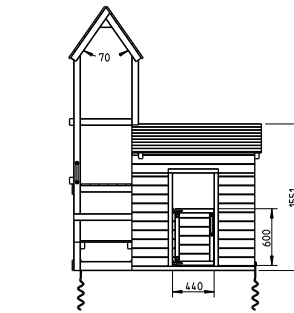

②

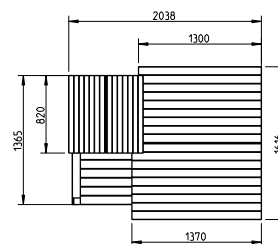
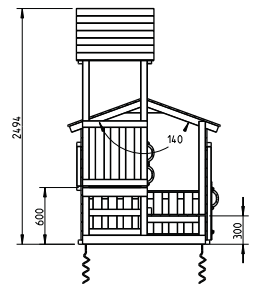
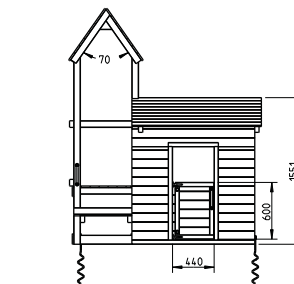

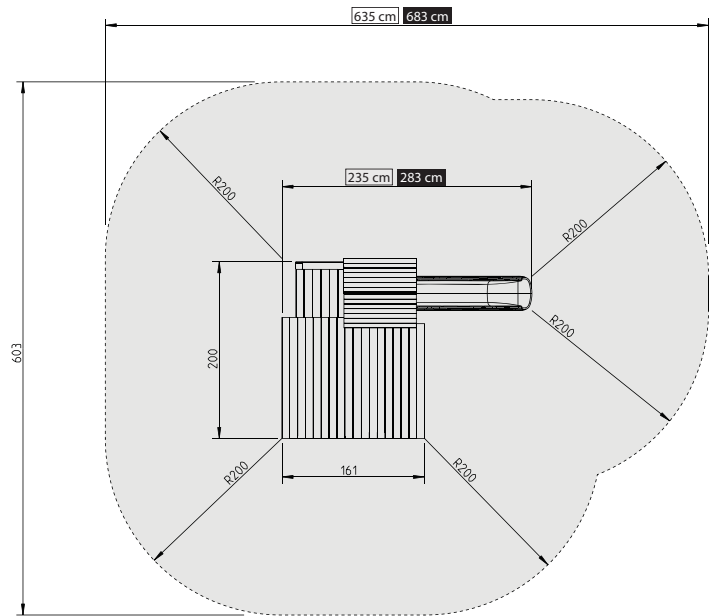
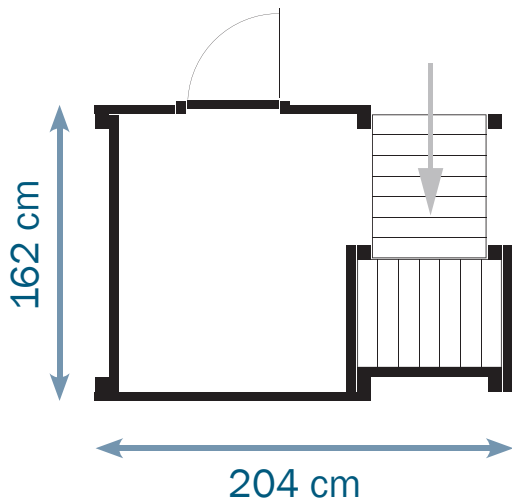

				@challenger 008.003.007.001 	
				@swing 008.003.005.001 	
Lookout 008.001.008.001 	90 cm	X	Ⓐ	X	↳
	60 cm	Ⓐ	X	X	X



53 x 23 x 12 cm



8,0 kg

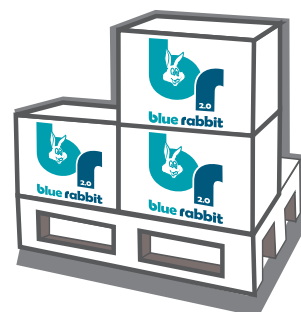

50





120 x 80 x 99 cm

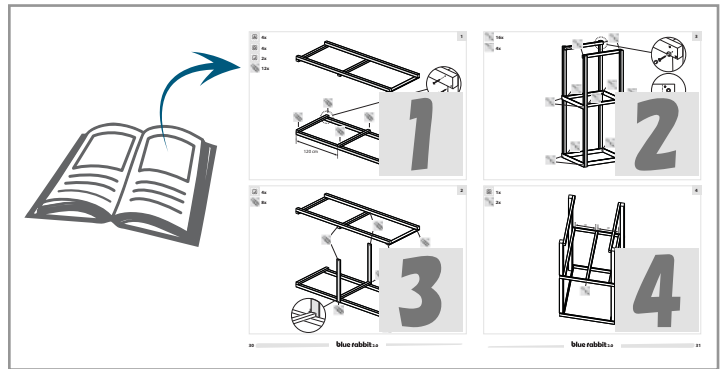
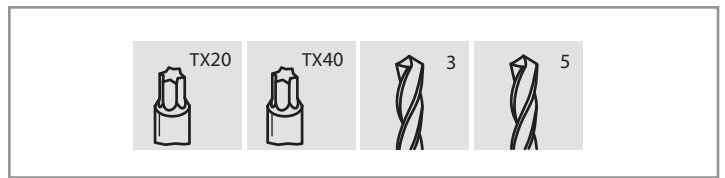

425 kg

			30 mm - 45 mm - 80 mm
			45 mm - 80 mm
			50 mm - 80 mm
10x			30 mm
2x			70 mm
2x			
1x			
1x			
2x			
5x			



4x **A** min 68 mm max 90 mm  200 cm 230 cm

min 68 mm
max 90 mm

3x **B** min 68 mm max 90 mm  130 cm

min 68 mm
max 90 mm

1x **C** min 68 mm max 90 mm  30 cm

min 68 mm
max 90 mm

2x **D** min 68 mm max 90 mm  130 cm

min 32 mm
max 50 mm

4x **E** min 68 mm max 90 mm  84 cm 70°

min 32 mm
max 50 mm

10x **F** min 68 mm max 90 mm  68,5 cm

min 32 mm
max 50 mm

2x **G** min 68 mm max 90 mm  65 cm 70°

min 32 mm
max 50 mm

2x **H** min 68 mm max 90 mm  min 56 / max 58 cm 70°

min 32 mm
max 50 mm

6x **I** min 44 mm max 45 mm  130 cm

min 44 mm
max 45 mm

2x **J** min 44 mm max 45 mm  min 91,5 / max 105,5 cm

min 44 mm
max 45 mm

1x **K** min 44 mm max 45 mm  65 cm

min 44 mm
max 45 mm

3x **L** min 44 mm max 45 mm  53 cm

min 44 mm
max 45 mm

2x **M** min 44 mm max 45 mm  51 cm

min 44 mm
max 45 mm

2x **N** min 44 mm max 45 mm  min 27 / max 43 cm

min 44 mm
max 45 mm

2x **O** min 44 mm max 45 mm  41 cm

min 44 mm
max 45 mm

6x*/9x** **P** min 95 mm max 145 mm  min 137 / max 139 cm

min 15 mm
max 22 mm

16x*/22x** **Q** ** min 95 mm * max 145 mm  130 cm

min 15 mm
max 22 mm

2x **R** min 95 mm max 145 mm  min 116 / max 120 cm

min 15 mm
max 22 mm

10x*/14x** **S** ** min 95 mm * max 145 mm  82 cm

min 15 mm
max 22 mm

8x*/9x** **T** ** min 95 mm * max 145 mm  68,5 cm

min 15 mm
max 22 mm

8x*/9x** **U** ** min 95 mm * max 145 mm  min 52,5 / max 55 cm

min 15 mm
max 22 mm

10x*/15x** **V** ** min 95 mm * max 145 mm  min 50,5 / max 55 cm

min 15 mm
max 22 mm

22x*/32x** **W** ** min 95 mm * max 145 mm  43 cm

min 15 mm
max 22 mm

7x*/9x** **X** ** min 95 mm * max 145 mm  41 cm

min 15 mm
max 22 mm

2x **Y** min 95 mm max 145 mm  30 cm 55° 55°

min 15 mm
max 22 mm

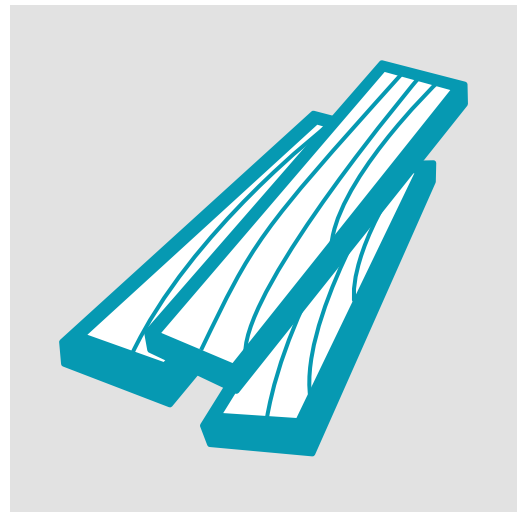
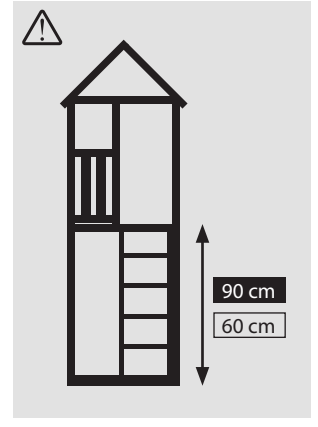



Blue Rabbit 2.0®
Hemelrijken 8
B-2890 Sint-Amands
BELGIUM

info@bluerabbit.be

www.bluerabbit.be